

TIGER WORM TOILETS

Design Manual

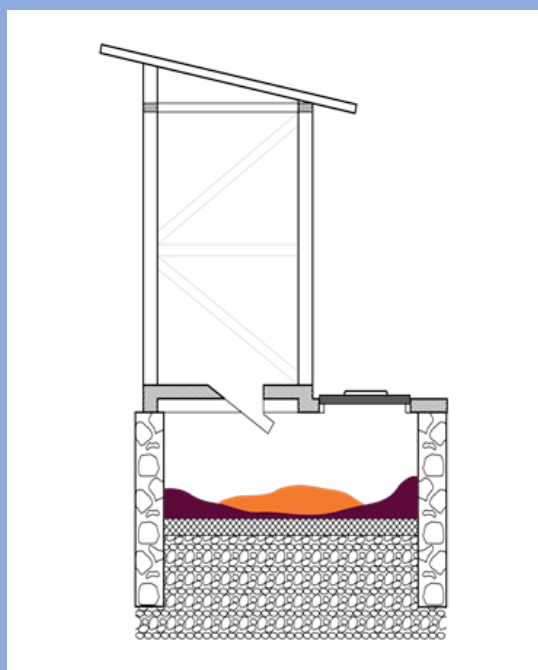

CONTENTS

03	Introduction to Tiger worm toilet design
04	Toilet design factors
07	Determining which TWT design is the right one for your situation.
08	Different TWT designs
11	Design 1 - Direct Drop Pour Flush TWT
16	Design 2 - Raised Direct Drop pour Flush TWT
18	Design 3 - Offset Pour Flush TWT
19	Design 4 - Raised Offset Pour Flush TWT
21	Design 5 - Raised Offset Pour Flush TWT
27	Design 6 - Direct Drop Pour Flush TWT
28	Design 7 - Offset pour Flush TWT
30	Acknowledgements
31	References and Further Reading

Introduction to Tiger worm toilet design.

This part of the manual will go through the tiger worm toilet design factors. It will look at the key technical elements of the toilet and how it differs from other latrines. Then there is a section emphasising the importance of high quality of construction.

The infiltration capacity of the soil is key in determining if the ground conditions are suitable for tiger worm toilets, how to calculate this is gone through in detail. The minimum infiltration capacity of the soil then determines if a subsurface pit can be excavated.

Other important design factors which are looked at are the number of users per toilet, the quantity of worms per toilet and the surface area of the pit which all impact on the design.

There is then a section on determining which is the right tiger worm toilet for your situation including a table showing the advantages and disadvantages of different designs.

From page 9 there is a section with the different types of design Oxfam has used in different locations, there are bill of quantities as well as construction guides for these toilets.

Please read make sure you have read “Tiger worm toilets, what are they? Are they a good solution for you? Before you decide on a design and if tiger worm toilets are the right solution in your location.

Toilet DESIGN FACTORS

The superstructure of a TWT can be the same as existing traditional latrines, as long as there is a roof to prevent rainwater entering the system. As with all latrines, it is essential that the community are consulted regarding the design, location and sharing arrangements.

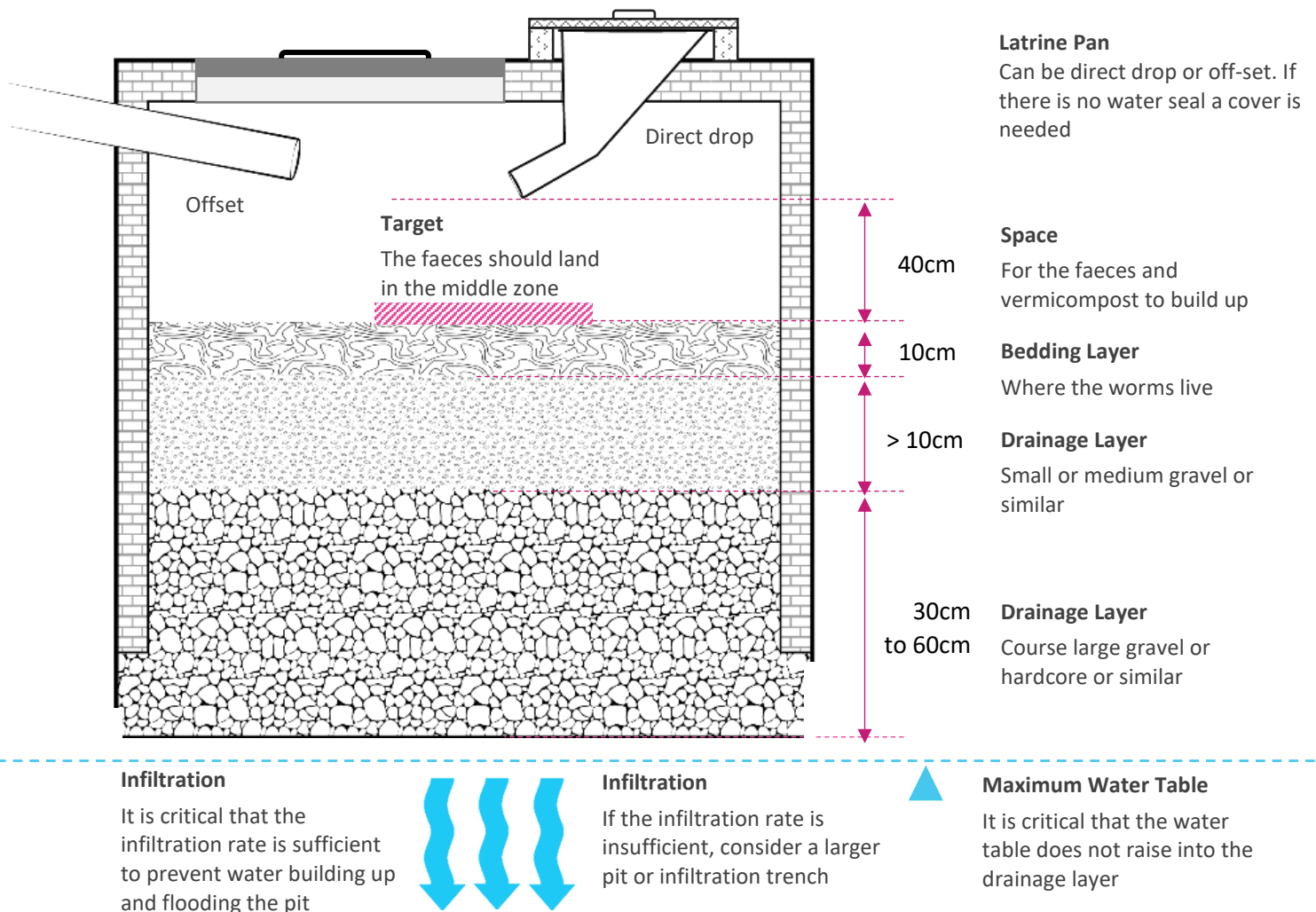

The importance of construction quality

Ensuring good construction quality is particularly important for TWTs. This includes ensuring:

1. The system is properly sealed to prevent predators such as rats or centipedes from being able to enter the pit. The pit lid needs to be well sealed. If direct drop, a good fitting latrine pan cover is needed.
2. The pit is properly sealed on the sides to prevent rain and surface water entering the pit.
3. A well-sealed and large enough emptying and monitoring hatch.
4. The correct construction materials are used. The drainage and bedding layer do not contain too many small fine particles which could cause blockages.
5. The inlet pipe is installed correctly for new faeces to land in the center of the pit

Toilet DESIGN FACTORS

Drainage Layer

The drainage layer supports the bedding layer and provides an infiltration buffer zone where water can be held while waiting to infiltrate. The whole drainage layer should be at least 40cm deep. Depending on local materials, it may be preferred to place finer gravel (or similar) above a layer of courser gravel or hardcore (or similar). Ensure that there are not too many fine/small pieces which could cause clogging.

Bedding Layer

This is where the worms live. It should be an organic material that does not quickly degrade, retains moisture, retains its structure to keep air flowing through the layer (aerobic) and filters out the solids that are flushed. Wood chips are ideal and coconut husks are also suitable. Ensure that there are not too many fine particles which could cause clogging. A depth of 10 cm is required to ensure that the worms have enough space to live and move around. The bedding layer must be soaked overnight in water before installation.

Space

There should be at least 40cm between the top of the bedding layer and the bottom of the entry pipe. This is the space where the vermicompost will build up and the fresh faeces will be processed.

Inlet pipe

The inlet pipe should be positioned in such a way that the faeces entering the pit lands in the middle. This can be easily tested during construction with a lump of wet tissue to simulate the faeces. If the tissue does not land in the central target zone then the pipe should be adjusted.

Latrine pan

Any type of latrine pan can be used, but low-volume pour flush pans are ideal. High volume pour flush pans will result in a lot more water entering the pit and potentially building up if the infiltration rate is not sufficient. They also require users to carry more water. Direct drop pans can be used if people use at least 1 to 1.5 litres per use for anal cleansing and pan cleaning.

Pit construction

The pit can be constructed from any suitable locally available materials. Bricks and concrete rings are common choices. In Rakhine the communal TWTs were constructed with a stone wall pit sealed with mortar. Whatever material is selected the pit must be properly mortared and sealed to prevent surface water runoff, animals and insects from entering the pit.

Monitoring and emptying hatch

TWT pits need to easily be visually inspected. A monitoring and emptying manhole cover is required. It should be easy to open and close. It should be large enough that the vermicompost can be emptied with a spade. A minimum of 0.6m x 0.6m is suggested, but larger is preferable. It is important that it has a good seal to prevent water and insects from entering the pit.

Toilet DESIGN FACTORS

Determining the minimum infiltration capacity of the pit

The required infiltration capacity will depend on the type of latrine pan used and user behaviours. This can be determined using the method and formulas included in the annex. The table below provides a quick guide by applying several general assumptions.

Flush volume	Flushes per day		
	2	3	4
1 litre	1.5 mm/hr	1.5 mm/hr	2.0 mm/hr
5 litres	3.5 mm/hr	5.0 mm/hr	6.0 mm/hr
10 litres	6.0 mm/hr	8.5 mm/hr	11.5 mm/hr

Suggested minimum design infiltration rates: table above assumes 1 litre for anal cleansing pppd, 1.5 litre urine pppd, adds a +25% safety factor, assumes 0.2m² pit surface area per person and is rounded up to the nearest 0.5mm/hr.

Determining the actual infiltration capacity of the pit

A simple infiltration test can be carried out and is essential for confirming that the actual infiltration capacity of the pit is greater than the required minimum design infiltration rate.

The below method is adapted from appendix H2 of the Building Regulations 2002 for England and Wales.

1. Excavate a test pit down to the expected level of the bottom of the TWT pit drainage layer. Ensure that this is above the highest level of the water table in the rainy season. The size at the bottom of the test pit should be large enough for the trial holes.
2. At the bottom of the test pit, dig two round trial holes with a diameter at the base of 300mm. Keep the sides of the holes as vertical as the soil type will allow. Space the top of the holes at least 300mm apart.
3. Fill the trial holes and allow to drain overnight.
4. The following morning fill the holes to a depth of 300 mm. Pour gently so to not disrupt the soil.
5. Record the time in minutes required for the water level to drop from 225mm to 75mm, a drop of 150mm.
6. Repeat this, three times per hole.
7. Calculate the average time of all 6 tests.
8. Calculate the design infiltration rate using the formula below. It is recommended to reduce the calculated infiltration rate by multiplying by a safety factor of 0.6 to allow for some future reduction in infiltration rate that could be caused by clogging.

$$\text{Design Infiltration Rate (mm/hr)} = \left(\frac{150 \text{ mm} \times 60}{\text{Average time in minutes}} \right) \times 0.6 \text{ Safety factor}$$

Determining the required infiltration capacity of the pit see **Annex 4**.
Infiltration test sheet template in **Annex 6**.

Toilet DESIGN FACTORS



Number of Users per Toilet

The number of users determines the number of worms that are required, which then determines the surface area of the pit that is required.



Quantity of Worms per Toilet

Composting worms have the ability to consume their own body weight in waste each day. An average person produces 200gr of faeces per day. Therefore at least **200gr of worms are required per person.**

m²

Surface Area of the Pit





Each **1 kg of worms requires at least 0.5m² surface area** of bedding layer. This is equivalent to **0.1m² per person** who will use the toilet. The minimum suggested surface area is 0.7m².



Soil Infiltration Rate

It is essential that the bedding layer does not become saturated and that the pit is able to infiltrate the daily input of water without accumulating above the drainage layer. If the soil does not have sufficient infiltration ability for the area of pit determined by the number of people (above), then either (1) the pit will need to be made larger until the infiltration capacity is sufficient, or (2) additional alternative infiltration will be required, such as infiltration trenches.

The following table provides a guide as to the expected quantity of worms and surface area required for different numbers of toilet users, together with the associated minimum internal diameter for a round pit or minimum internal length for a square shaped pit.

		m²		
5 people	1 kg	0.7	> 0.9 m	> 0.8 m
10 people	2 kg	> 1.0	> 1.1 m	> 1.0 m
20 people	4 kg	> 2.0	> 1.6 m	> 1.4 m
30 people	6 kg	> 3.0	> 2.0 m	> 1.7 m

*TWTs can be designed for more than 30 people by following the design guidance above.

Determining which TWT design is the right one for your situation.

Below is a list of questions which will help form the basis of the design for an appropriate sanitation system.

What is the Scenario? Urban, Peri urban or rural has there been a natural disaster, earthquake, Tsunami or flood. Is the affected population densely packed or spread out.

Can you excavate? The importance of Soil type – rocky, very hard, very soft sand to be determine.



What is the ground permeability? Infiltration capacity of the soil to determine ground conditions.

Where is the water table level? i.e. groundwater considerations regarding contamination and whether underground structures might flood.

What are the Cultural norms for sanitation? – communal, family household, gender separated

What are Anal Cleansing practices? – wet or dry

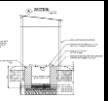
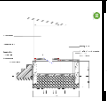
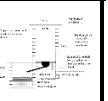
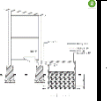
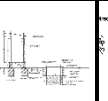
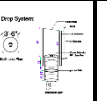
Table comparing use of different designs.

	Design 1	Design 2	Design 3	Design 4	Design 5	Design 6	Design 7
							
Household	X		X	X	X	X	X
Communal		X					
Limited space	X	X	X			X	X
Areas with risk of Flooding (High water table)		X		X			X
Suitable for Camp setting		X		X			
Suitable for urban peri urban	X		X		X	X	X
Suitable for poor soil infiltration				X		X	

Different Types of Tiger Worm Toilet DESIGNS

There are a range of designs to accommodate differing conditions, See below.

Design 1

Direct Drop Pour Flush
Family
Used in Ethiopia

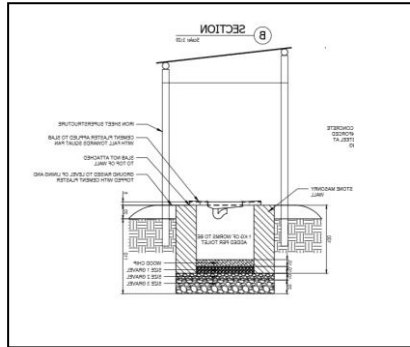

Design 2

Raised Direct Drop pour Flush
Communal
Used in Myanmar

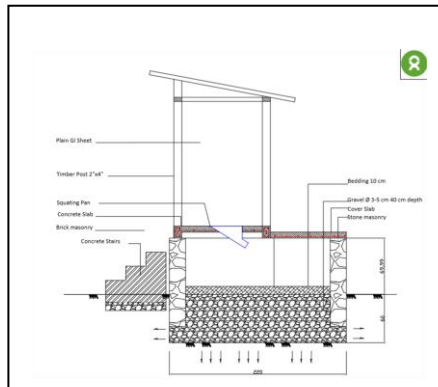

Design 3

Offset Pour Flush
Family
Used in Ethiopia

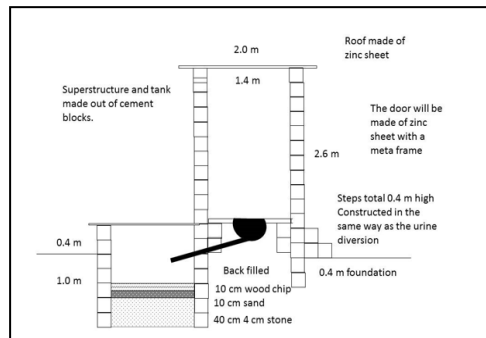

Design 4

Raised Offset Pour Flush
Family
Used in Myanmar

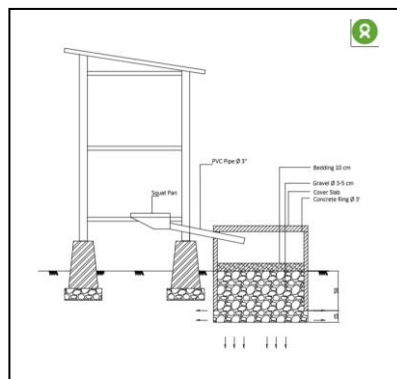

Conditions for use

Limited Space,
urban/peri urban,
Good soil
infiltration

Limited Space
High-water table
<1m
Risk of Flooding
Camp setting

Limited Space
Good soil
infiltration
Urban Peri Urban

Poor soil infiltration
If high-water table
<1m
Suitable for areas
with Risk of
Flooding
Rural

Design 5

OffSet Pour Flush
Family
Used in India

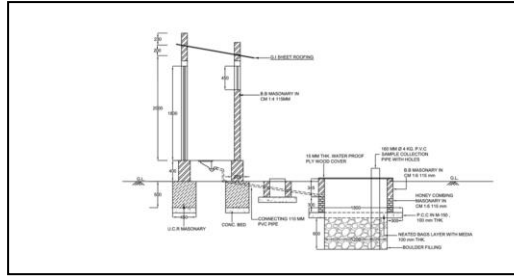

Large footprint
Good Soil
Infiltration
Peri Urban

Design 6

Direct Drop Pour
Family
Used in Bangladesh

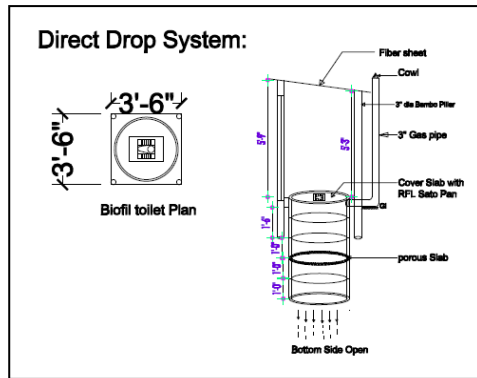

Flush

Reinforced
concrete rings
Small footprint
Cheap
Urban/ Peri Urban
Good Soil
Infiltration

Design 7

Offset pour Flush
Family
Used in Sierra Leone

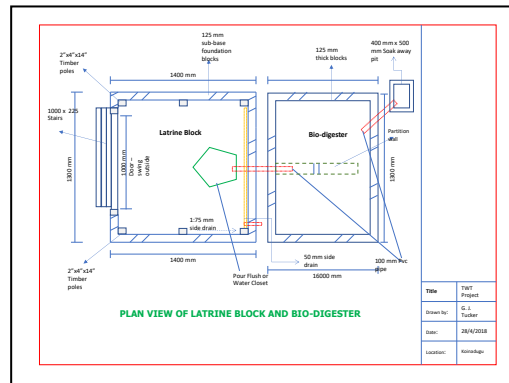

Biodigester is
separate could be
retro fitted
Above ground
Risk of Flooding
High Water table
Peri Urban

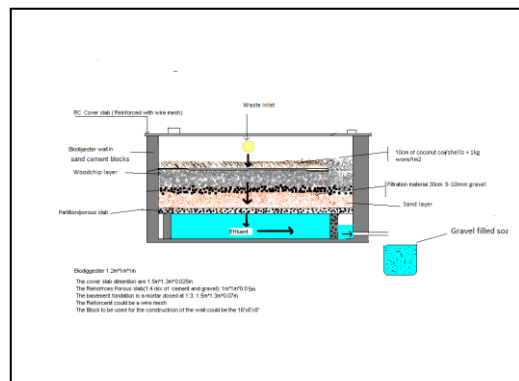

Design 1 - Direct Drop Pour Flush TWT

Use for: Household, Limited Space and urban / peri urban.

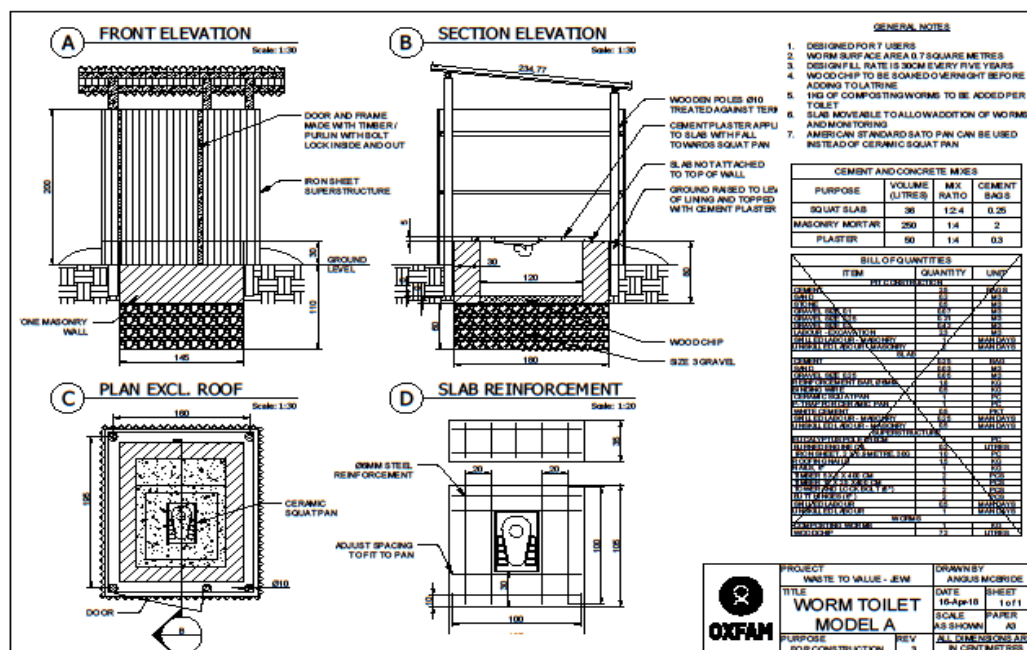
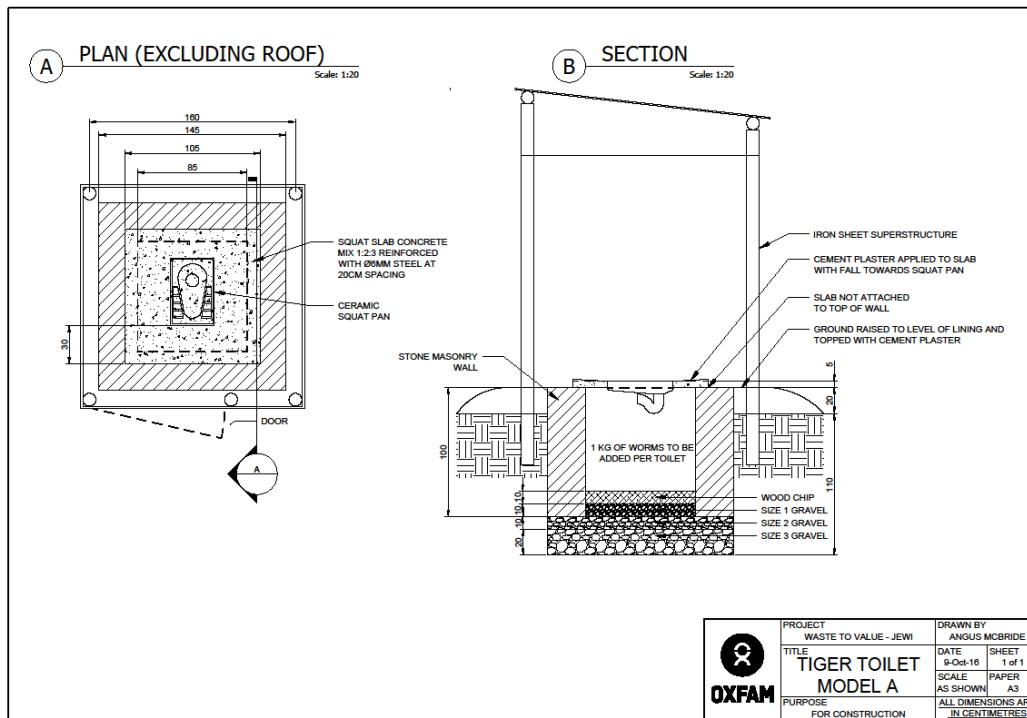

Construction Guide

Off-Site Preparation

1. Cast the slab for the toilet off-site. Ensure that when it is cast that it is smooth and level on the bottom. The smaller part has handles so that it can be moved easily for monitoring purposes.
2. If the worms are being housed in a wormery before going inside the pit, they need sorted and weighed before they can be put in the pit. Don't start this until you are ready to put them in the pit, but also don't underestimate the amount of time this can take. Even one kilogram is a lot of worms.



On-Site Construction

3. Dig the pit to the appropriate dimensions. The optimum depth can be determined by infiltration tests on the soil (see Design section).



4. Fill the bottom of the pit with aggregate. This is the soakaway area, as well as acting as a buffer against particularly high rates of water entry.



5. Construct the walls of the pit.



6. Level the top of the pit, and then put the slab on top. It should fit neatly. Attach the slab using a cement mortar but leave the access hatch so that it can easily be opened.



7. Erect the superstructure, which should be suitable for the context. If there is a risk of termites in the area, then ensure all poles are dipped in burned engine oil.
8. Add the bedding layer, ensuring that it has been thoroughly wetted first.
9. Add the worms and start using the toilet straight away.



Bill of Quantities - FOR WORM TOILET MODEL A

Item description	Quantity	Unit
Pit Construction		
Cement	2.5	50kg bags
Sand	0.2	m ³
Gravel Size 0.1	0.1	m ³
Gravel Size 0.25	0.2	m ³
Gravel Size 0.3	0.4	m ³
Stone	0.5	m ³
Slab		
Cement	0.25	50kg bags
Sand	0.03	m ³
Aggregate	0.05	m ³
Reinforcement bar, Ø6mm	1.8	kg
Binding Wire	0.5	kg

Squat Pan	1	pieces
Superstructure		
Eucalyptus pole Ø8cm	4	pieces
Timber 5 x 4 x 200 cm	2	pieces
Timber 15 x 2.5 x 200cm	1	pieces
Burned Engine Oil	2	litres
Iron sheet, 2 x 0.9 m, 32G	10	pieces
Nails, Roofing	1.5	kg
Nails, 9cm	1	kg
Tower Bolt,15cm	2	pieces
Butt Hinge, 15cm	2	pieces
Worms		
Composting Worms	1	kg
Bedding Layer	72	litres

Design 2 - Raised Direct Drop pour Flush TWT

Use for: Communal, limited space, high water table and camp setting.

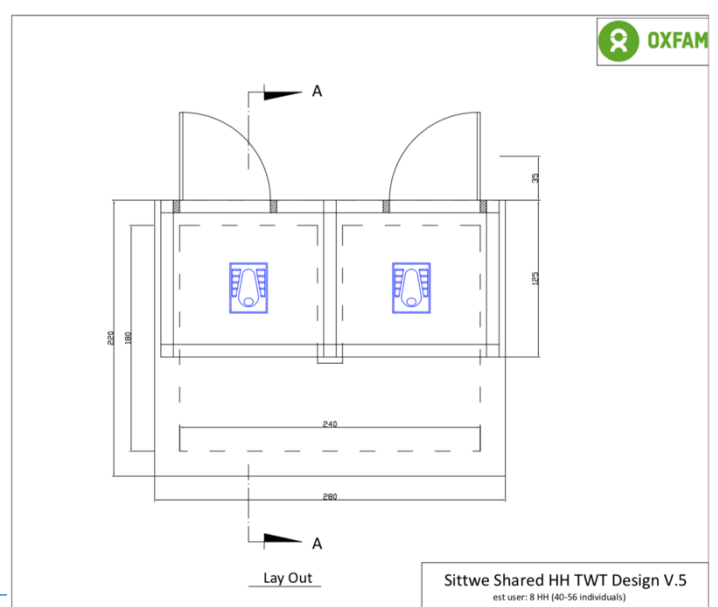
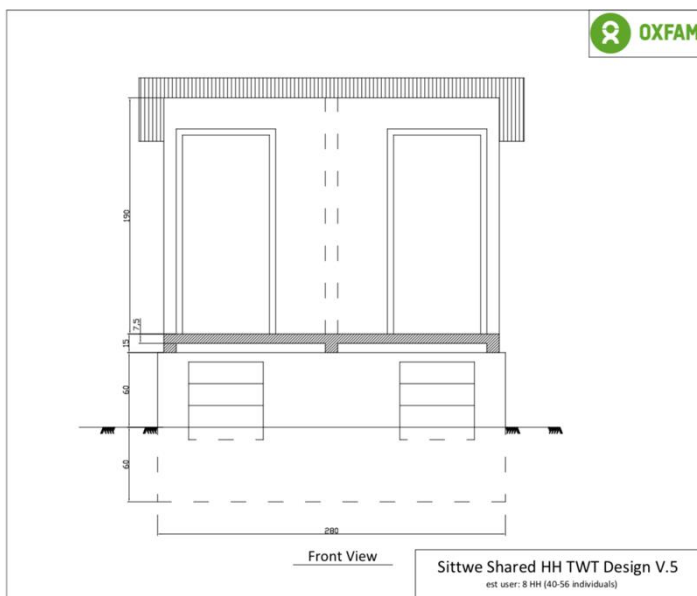
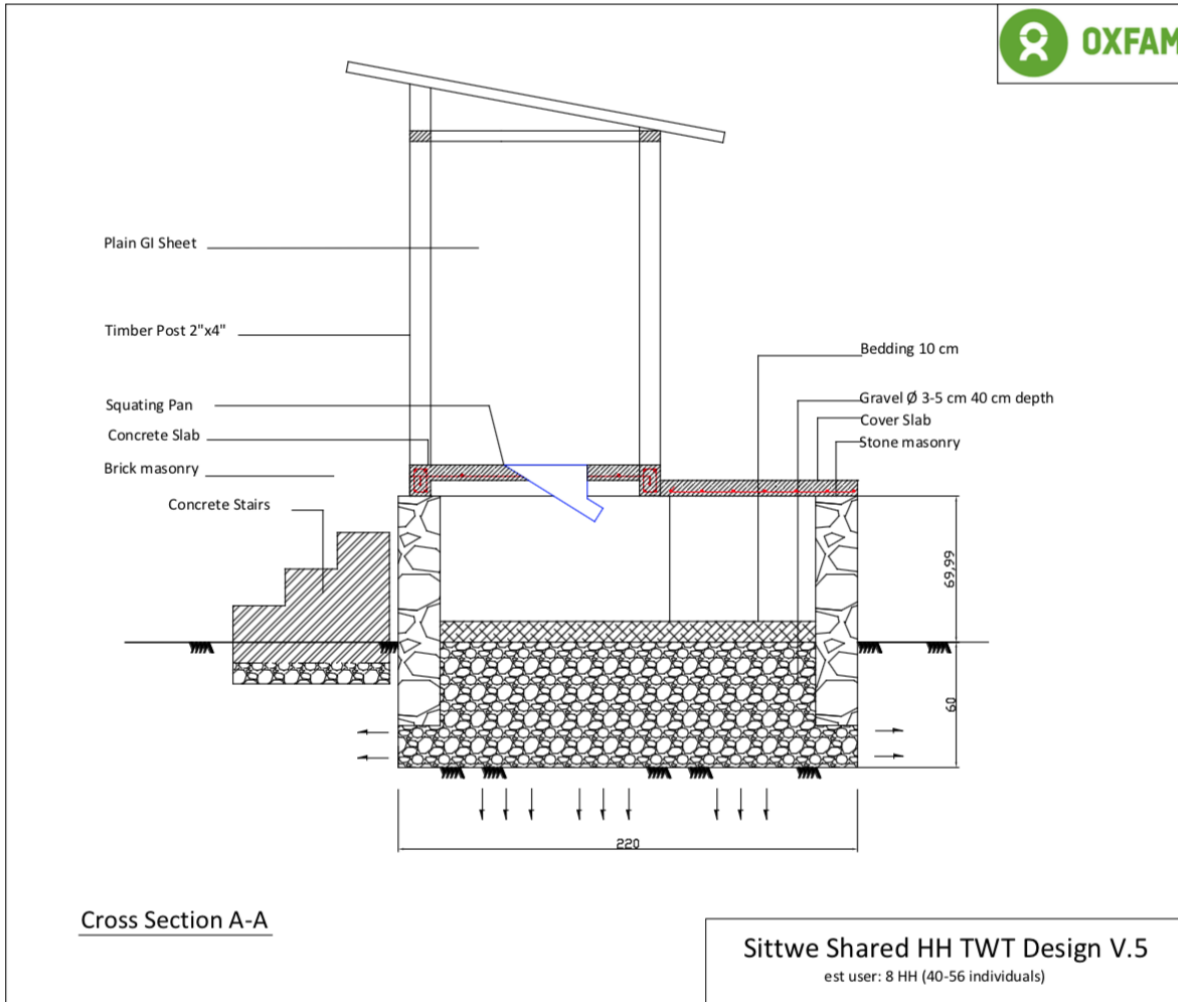

Bill of Quantities - for Shared Sittwe HH TWT Design V.5

Sr.No.	Description	Quantity	Unit
	Material		
1	Hard wood 3" x3" post 9' length	6	pcs
2	3" x 2" hard wood 12' length	15	pcs
3	3"x1" hard wood 12' length	3	pcs
4	3" x 0.5" hard wood for beading	13	pcs
5	pan cover with 5 ply wood, 2" x1" frame	2	pcs
6	8mm rebar	240	Rft
7	6 mm rebar	160	Rft
8	binding wire	0.5	viss
9	vernish (1 gal)	1	gal
10	cement	22.34	bags
11	boulder	3.225	sud
12	Aggregate	0.25	sud
13	sand	1	sud
15	brush	2	pcs
16	GI plain sheet (5 ft)	55	ft
17	C.G.I roofing sheet	4	pcs
18	roofing nail	1	viss
19	nail (various size)	1.5	viss
20	1/2" dia Bolt and Nut 5" long with washers	12	pcs
21	pan	2	pcs
22	3" dia PVC pipe 4'	2	nos
24	fly screen 4'	15	ft
25	4" Hinge	6	pcs
26	4" handle	4	pcs
27	tower bolts	2	pcs
28	padlock	2	pcs
29	Bedding material/coconut coir	25	bags
	Labour cost		
	carpenter	2	mandays
	mason+ steel fixer	5	mandays
	worker	8	mandays

Design 3 - Offset Pour Flush TWT

Use for: Household, limited space, urban and peri urban.

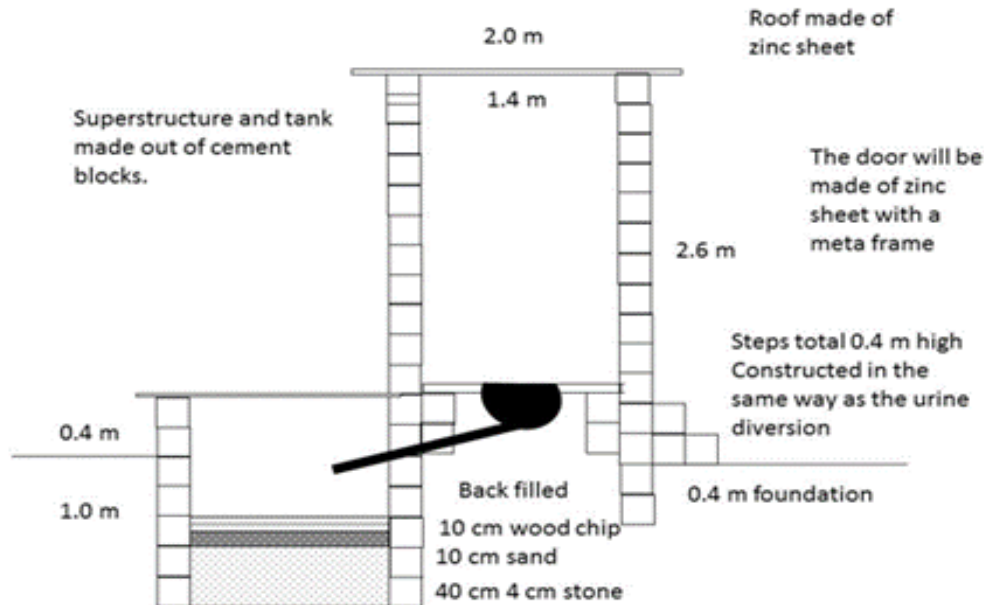

Figure 27: Design of a TWT installed in Ethiopia. The cost of the system was reduced by incorporating the biodigester wall into the superstructure wall [4].

Installation of the pour flush pan and plumbing – case examples from Ethiopia

These are the main steps in the installation of the pour flush pan and plumbing as implemented in Ethiopia [4]:

- Backfill partially the foundation of the superstructure with the soil from the excavation.
- Position the toilet pan at the level of the slab which it will be set into.
- Install a 70-mm-diameter and one-meter long pipe connecting the biodigester to the pan (in Liberia, a 4-inch-diameter PVC pipe has been used)
- Further backfill the foundation with soil up to 20 cm below the level of the slab. The rest of the space should be backfilled with sand.
- Lift the slab and connect the pan to the pipe. The angle of the pipe should be 15 degrees.
- Once in the correct position, mortar the pan in place and seal the side of the slab.

Once the plumbing system is installed, screw up several large handful of toilet paper, wet them and make them into balls. Then flush one down the toilet with two litres of water, repeat this and note where the ball lands. Ideally it should land in the middle of the tank, trim the inlet pipe until this occurs.

Design 4 - Raised Offset Pour Flush TWT

Use for: Household, high water table, camp setting, poor or low soil infiltration.

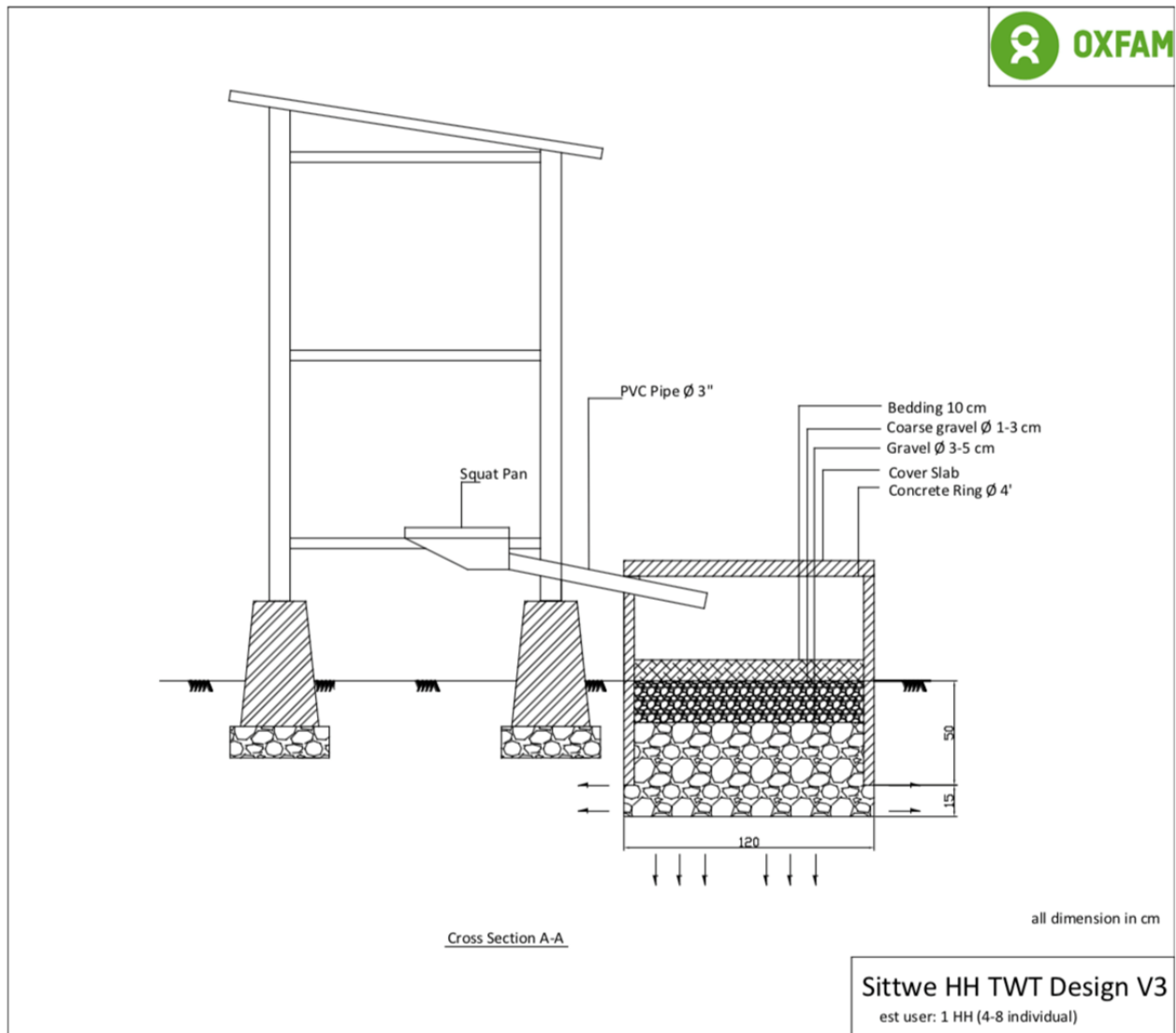

Bill of Quantities - for single Sittwe HH TWT Design V3.

Sr.No.	Description	Quantity	Unit	Per
	Material			
1	Hard wood 3" x3" post 9' length	4	pcs	pcs
2	3" x 2" hard wood 12' length	9	pcs	pcs
3	3"x1" hard wood 12' length	2	pcs	pcs
4	3" x 0.5" hard wood for beading	9	pcs	pcs
5	6" x 1" plank 12 length	5	pcs	pcs
6	pan cover with 5 ply wood, 2" x1" frame	1	pcs	pcs
7	1"x 1" wire mesh	0.04	roll	roll
8	concrete footing with M.S flat (8" x 1' x 1.5')	4	pcs	pcs
9	concrete ring (3' dia, 1.5' height)	2	pcs	pcs
10	reinforced concrete cover with man hole (3' dia)	1	pcs	pcs
11	vernish (1 gal)	1	gal	gal
12	cement	0.76	bags	bags
13	boulder	0.125	sud	sud
14	Aggregate	0.038	sud	sud
15	sand	0.019	sud	sud
18	brush	2	pcs	pcs
19	GI plain sheet (5 ft)	30	ft	ft
20	C.G.I roofing sheet	2	pcs	pcs
21	roofing nail	0.5	viss	viss
22	nail (various size)	1	viss	viss
23	1/2" dia Bolt and Nut 5" long with washers	8	pcs	pcs
24	pan	1	pcs	pcs
25	3" dia PVC pipe 4'	1	nos	nos
26	tarpaulin sheet 4' x 4'	0.04	roll	roll
28	fly screen 4' x 5'	5	ft	ft
29	4" Hinge	3	pcs	pcs
30	4" Handle	2	pcs	pcs
31	tower bolts	2	pcs	pcs
32	bedding material/coconut coir	5	bags	bags
	Labour cost			
	carpenter	2	mandays	
	mason	1	mandays	
	worker	4	mandays	

Design 5 - Raised Offset Pour Flush TWT

Use for: Household, peri urban.

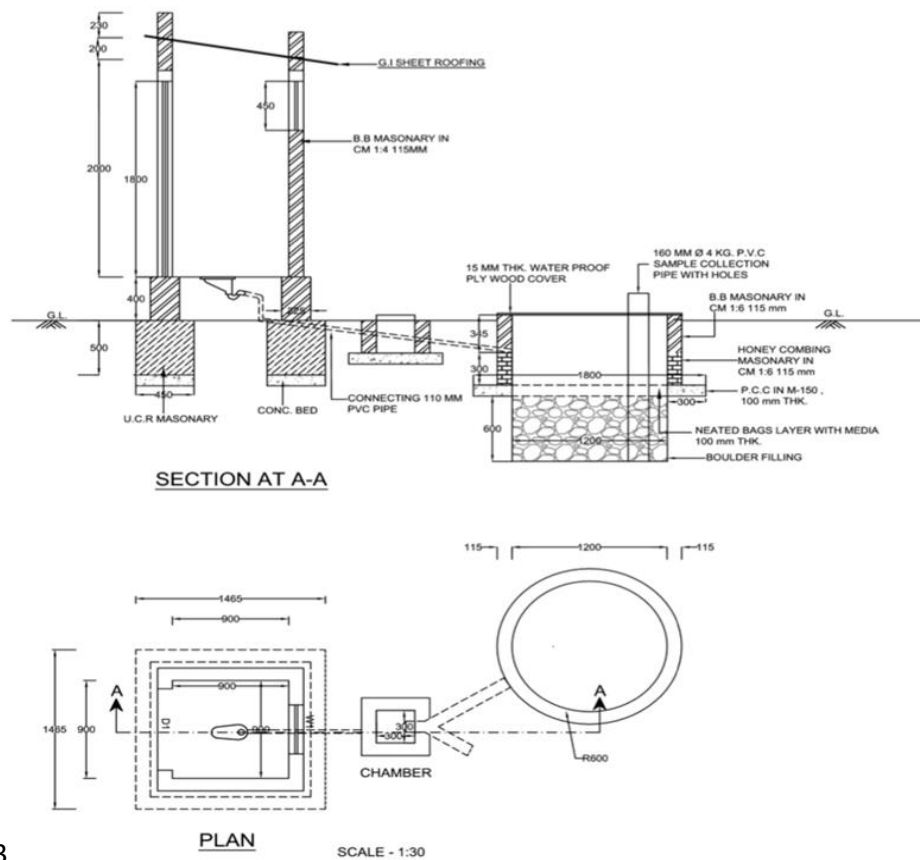

3

Design of a TWT built in India (note: all dimensions are in mm)

Construction of the biodigester, Above-ground biodigester – case example from Liberia. For areas prone to flooding.

Build a 7 cm concrete foundation with the surface of 1.52m*1.32m (Picture 1).



Picture 1: Building of a concrete foundation for an above ground biodigester, Liberia.

The internal dimensions of the biodigester should be 1.2 m high, 1 m long and 1 m wide. Plaster the outside and internal walls with mortar.



Picture 2: Construction of an above ground biodigester.

Construct **the walls of the biodigester** by using 6'' (15.24 cm) concrete blocks and mortar (picture 2).

Construct **the lid** of the biodigester by pouring a slab of reinforced concrete (picture 3). The dimensions of the lid should fit with the surface of the biodigester (i.e. 1.52*1.32m). The recommended thickness is 0.05m.



Picture 3: Pouring of a cover slab, Liberia.

Installation of the inner parts of the biodigester – case examples from Ethiopia and Liberia

Firstly, set up the drainage layer. For example, in Ethiopia and Liberia, the drainage layer consists respectively of a superposition of 30 cm of 4 cm aggregate and 10 cm of sand and of a superposition of 15

cm of sand, 5 cm of charcoal, and 10 cm of gravel (Picture 4 & 5). Alternative materials can be used provided they can be climbed by worms (e.g. plastic bottles or pipes).



Picture 4: Set-up of the bottom layer and the intermediate layer of the drainage layer, i.e. 15 cm of sand and 5 cm of charcoal, Liberia.



Picture 5: Set-up of the upper layer of the drainage layer, i.e. 10 cm of gravel, Liberia.

In Liberia, a **reinforced porous slab** has been installed below the drainage layer to further filter the effluent (picture 6). The slab has been precast, using 1:3 cement mix and ¼" gravel. The surface of the slab should be a bit smaller than the inner surface of the biodigester, i.e. 1.1m*0.9m. The thickness of the slab should be minimum 5 cm, which is the structural minimum for the load. To increase the porosity of the slab, it is recommended to insert wires into the slab two hours after casting and to leave it until the following day. A proper porosity is crucial to ensure the flow of the effluent liquid.



Picture 6: Precast reinforced porous slab, Liberia.

Secondly, set up a 10 cm **bedding layer** by using coir, vermicompost, woodchips and/or a combination of them.

In Liberia, **an additional intermediate layer** has been installed between the drainage layer and the bedding layer as well. This layer consists of a metal mesh or onion bags (picture 7). The goal is to help users empty the system by leaving that layer out and thus disposing the vermicompost easily.



Picture 7: Positioning of onion bags above the drainage layer, Liberia.

Finally, wet the bedding layer by pour 20 litres of water slowly across the top of the tank and add the worms by distributing them across the surface (picture 8). Then, close the tank lid and seal the joint between the lid and the tank.



Picture 8: Provision of worms to the biodigester.

Construction of the effluent collector – case example from Liberia

In Liberia the effluent collector has been constructed using a plastic drum with a lid and a 2'' PVC pipe (picture 9). The slope of the pipe between the biodigester and the effluent collector should be minimum 2%. A hermetic lid is needed to ensure that external water does not enter in the system. Moreover, in areas prone to flooding, it is recommended to raise protection walls around the effluent collector to protect it against flooding.



Picture 9: An effluent collector constructed with a plastic drum in Liberia. Protection walls have been raised around the drum to protect it against flooding.

Bill of Quantities -

Tiger worm Toilets household (biodigester 1.2m*1m*1m - connected to a house toilet)
for construction of a household TW Toilet

Item	Description	Qty	Unit (USD)	Unit cost (USD)	Total
1	Cement	7	50kg	9	63
2	Sand	1	m3	30	30
3	Crushed rocks 1/4"	0.3	m3	30	9
4	Poor flush squate/commode	1	pc	60	60
6	Mesh Wire (large roll)	4	m2	5	20
7	Onion bags	1.2	m ²	0.5	0.6
8	Fishing line	2	rl	1	2
9	Plumbing putty	0.25	can	5	1.25
10	PVC glue	0.5	can	5	2.5
11	4" PVC pipe	0.5	pc of 6m	18	9
12	4" PVC elbow	2	pc	3	6
13	Floor tiles (12"X12"ceremic)	1	ctn (11 pc)	15	15
14	Steel rods (1/4")	0.2	pc of 12m	10	2
15	Coconut shred	0.5	wb	10	5
16	2" PVC Elbow	2	pc	3	6
17	PVC Pipe 2"	0.5	pc of 6m	8	4
19	White cement	0.3	50kg	20	6
21	4" PVC coupling	1	pc	3	3
22	4" PVC Tee	1	pc	4	4
23	2" PVC Tee	1	pc	3	3
24	Reducer PVC 4"X2"	1	pc	3	3
25	Nail 2"	1.5	pck	2	3
26	Timber (2 x 4x 14)	2	6m	6	12
27	6" cement block	80	pc	0.56	44.8
28	Empty drum (plastic)	1	pc	30	30
29	Charcoal	1	wb	4	4
30	worms	2.4	kg	7	16.8
	Sub-Total				364.95
	Workmanship @ 25% x material cost	1	toilet	91.2375	91.2375
	Grand Total				456.1875

Design 6 - Direct Drop Pour Flush TWT

Use for: Household, limited space, urban and peri urban and low soil infiltration.

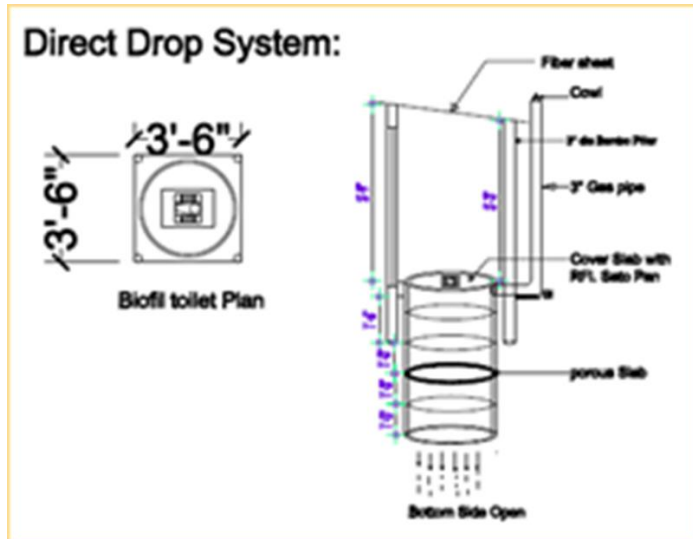

Design 7 - Offset pour Flush TWT

Use for: Household, limited space, high water table urban and peri urban.

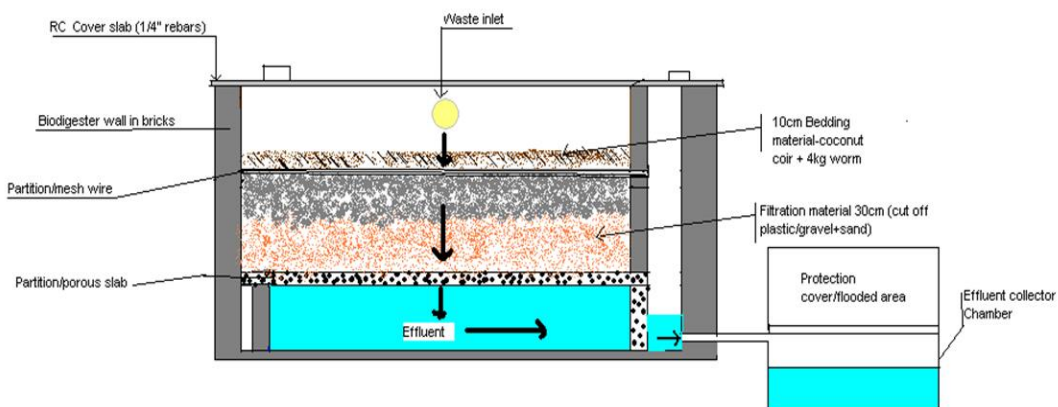
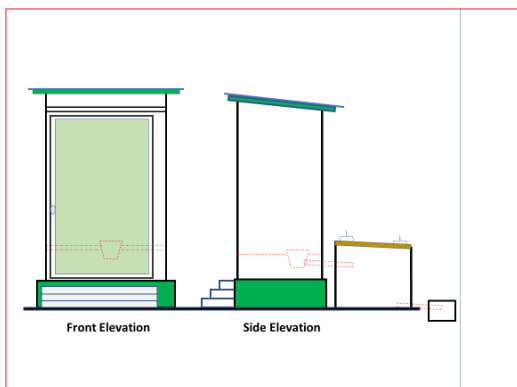
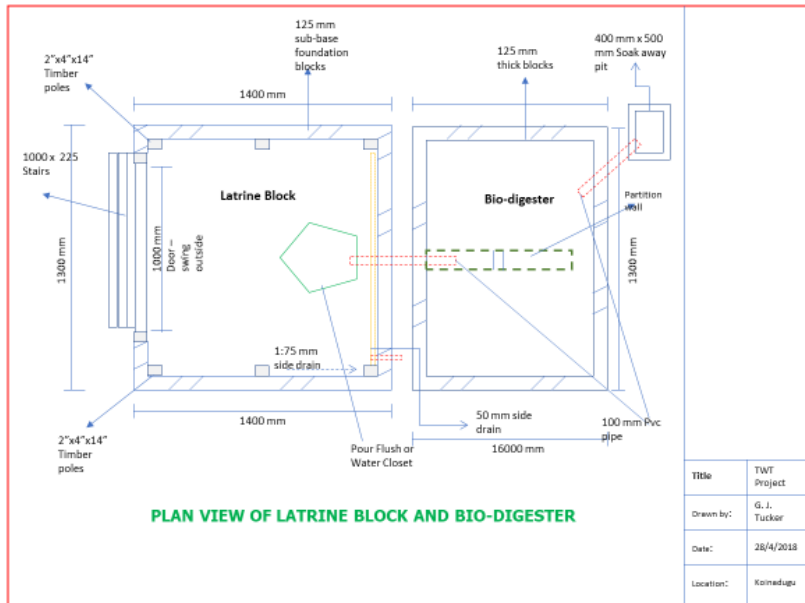

BILL OF QUANTITIES - FOR THE CONSTRUCTION OF TIGER WORMS TOILET

The materials are ONLY for the construction of the bio-digester and installation

Materials description	Unit	Quantity
Cement	50kg Bag	8
Sand (block work & building)	m3	2
Coarse Sand for bedding layer	m3	0.5
Aggregate 25mm (1") for concrete	m3	0.5
Crushed rocks (Aggregates) 1/4" for bedding layer, porous and top slabs.	m3	0.3
Pour flush square commode	pc	1
Mesh wire G10 2.4mX1.2m	m2	4
Onion bags	m2	1.2
Flushing line	roll	2
Plumbing putty	can	0.25
PVC glue	can	0.5
4" PVC pipe	pc of 6m	0.5
4" PVC elbow	pc	2
Floor tiles (12" x 12" ceramic)	ctn (11 pc)	1
Steel rods 1/4"	pc of 12 m	0.2
Coconut shred	wb	0.5
2" PVC elbow	pc	2
PVC pipe 2"	pc of 6m	0.5
10. White cement	50 kg	0.3
4" PVC Coupling	pc	1
4" PVC Tee	pc	1
2" PVC Tee	pc	1
Reducer PVC 4" x 2"	pc	1
Fly screen	pc	1
Nails 2"	pck	1.5
Timber 12 x 1	6m	2
Timber 3 x 2	no	4
Local bush poles	no	4
Galvanised iron sheets 2.4mx1.0m	no	6
5" cement block	pc	80
Empty drum (plastic 200lts)	pc	1
Charcoal	wb	1
Worms	kg	2.4
Water for construction use	litres	200

Acknowledgements

Oxfam has been working on Tiger Worm Toilets (TWT) for over a decade. Many Oxfam staff, consultants, private companies, have been involved in the gathering the information outlined in the manual. Numerous country programmes have implemented Tiger Worm toilet projects, Myanmar, Sierra Leone, Ethiopia, Liberia, Bangladesh and India. The experience gained and lessons learnt about design, operation and implementation are outlined in this manual.

It is with thanks to the following donors for their support to Oxfam: -

“Waste to Value” project funded by the Bill & Melinda Gates Foundation through UNHCR.

Elrha’s Humanitarian Innovation Fund, a grant making facility supporting organisations and individuals to identify, nurture and share innovative and scalable solutions to the most pressing challenges facing effective humanitarian assistance.



References and Further Reading

Processing of human faeces by wet vermifiltration for improved on-site sanitation

Furlong, C., Templeton, M.R., Gibson, W.T. 2014. Journal of Water, Sanitation and Hygiene for Development 4 (2) 231-239.

The ‘Tiger Toilet’: From Concept to Reality

Furlong, C., W. T. Gibson, M. R. Templeton, M. Taillade, F. Kassam, G. Crabb, R. Goodsell, et al. 106–11. Bangkok: Asian Institute of Technology, 2014.

The development of an onsite sanitation system based on vermifiltration: the ‘Tiger Toilet’

Furlong C., Gibson W.T., Templeton, M. R. Taillade M., Kassam F., Crabb G., Goodsell R., Mcquilk J., Oak A., Thakar G., Kodgire M., Patankar R. 2015 Journal of Water, Sanitation and Hygiene for Development 5 (4), 608-613.

Technical and user evaluation of a novel worm-based, on-site sanitation system in rural India

Furlong, C., Gibson, W.T., Oak, A., Thakar, G., Kodgire, M., Patankar, R. 2016. Waterlines, 35 (2), 148-162.

Compendium of Sanitation Technologies in Emergencies

Gensch, R., Jennings, A., Renggli, S., Reymond, P., 2018. German WASH Network (GWN), Swiss Federal Institute of Aquatic Science and Technology (Eawag), Global WASH Cluster (GWC) and Sustainable Sanitation Alliance (SuSanA). Berlin, Germany. ISBN: 978-3-906484-68-6.

Tiger worm toilets: lessons learned from constructing household vermicomposting toilets in Liberia

Watako D., Mougabe K., Heath T. 2016. Waterlines 35 (2), 136-147.

Applehof, M., (2003) Worms Eat My Garbage

Furlong, C., Lamb, J., Bastable, A. (2017) Learning from Oxfam’s Tiger Worm Toilets Projects, 40th WEDC International Conference

Bear Valley Ventures Ltd. “Tiger Toilet - A New Option for on-Site Sanitation - Vermifiltration,” n.d. <http://www.bearvalleyventures.com/#!tiger-1>.

Kassam, F. F. “Assessment of the Performance of a Novel, on-Site, Worm Based Sanitation System for Peri-Urban Environments,” 6. Imperial College London, 2012.

Furlong, Claire. “A Manual for the Tiger Toilet in Dire Dawa.” Oxfam, February 2013.

Koslengar, Mougabe, and David Watako. “Tiger Worm Toilets: Lessons Learnt from Constructing Household Vermicomposting Toilets in Liberia,” Oxfam 2015,

Furlong, Claire. “Worm Care Manual.” Bear Valley Ventures Ltd., October 2013.

Furlong, Claire. “Worm Farming in South Africa - Assessing the Potential to Supply Composting Worms for the Humanitarian Sector in Africa.” Bear Valley Ventures Ltd., International Federation of Red Cross and Red Crescent Societies, 2014.

Nalika, Rajapaksha, and Butt Kevin. "Supply Capability of Composting Earthworm in India." Bear Valley Ventures Ltd., University of Central Lancashire, July 2014.

Furlong, C., Templeton, M.R and Gibson, W.T. (2014). "Processing of human faeces by wet vermifiltration for improved on-site sanitation". Journal of Water, Sanitation and Hygiene For Development 4 (2) 231-239.

Bear Valley Ventures Ltd. "Tiger Toilet." Bear Valley Ventures - Social Ventures Incubator for Sanitation and Hygiene. Accessed September 29, 2015. <http://www.bearvalleyventures.com/#!tiger-1>.

Furlong, Claire. "Final Report: Assessment the Potential of Using Vermifilters to Treat Faecal Sludge." Bear Valley Ventures Ltd., International Federation of Red Cross and Red Crescent Societies, n.d.

Furlong, Claire. "Tiger Toilet: Monitoring Manual." Oxfam, March 2013.

Furlong, C., Templeton, M.R and Gibson, W.T. (2014). "Processing of human faeces by wet vermifiltration for improved on-site sanitation". Journal of Water, Sanitation and Hygiene For Development 4 (2) 231-239 in Bear Valley Ventures Ltd. "Tiger Toilet - A New Option for on-Site Sanitation - Vermifiltration," n.d. <http://www.bearvalleyventures.com/#!tiger-1>.